

Bicycle Trailer Assembly Instructions

Tools Required

two 7/16" x 1/2" wrenches (included)
 a 7/16" ratchet (not included) will speed assembly

Before you Begin

Layout and identify all the parts before starting.

Parts List	Model 32A	Model 64A	Model 96A
channel segments-7 holes/leg	2	2	2
channel segments-5 holes/leg	0	2	4
axle	1	1	1
long round crossmembers	2	2	2
short round crossmembers	1	3	5
splice plates	0	2	4
rectangular crossmembers	2	2	2
corner brackets	4	4	4
towbar and square spacer	1	1	1
towbar U-bolts, saddles, plates	2	2	2
5/16" locknuts	4	4	4
1/4" x 1-1/2" hex head bolts	20	24	28
1/4" x 3/4" hex head bolts	2	10	18
1/4" U-bolts & plain hex nuts	4	8	12
1/4" nylon insert locknuts	28	44	60
wheels, fenders, reflectors	2	2	2
wheel spacers and pins	2	2	2
hitch and mounting hardware	1	1	1
large round washers	2	6	10
elastic shock cords	2	4	6

1. Find the two 7-hole channel segments. These will have an "A" (for axle) stamped on the bottom of them. Attach the axle to the channel segments using two 1-1/2" bolts and locknuts as shown in Fig.1, using the holes adjacent to the A's. The hex head of the bolt should fit down between the ribs of the channel as shown in the detail.

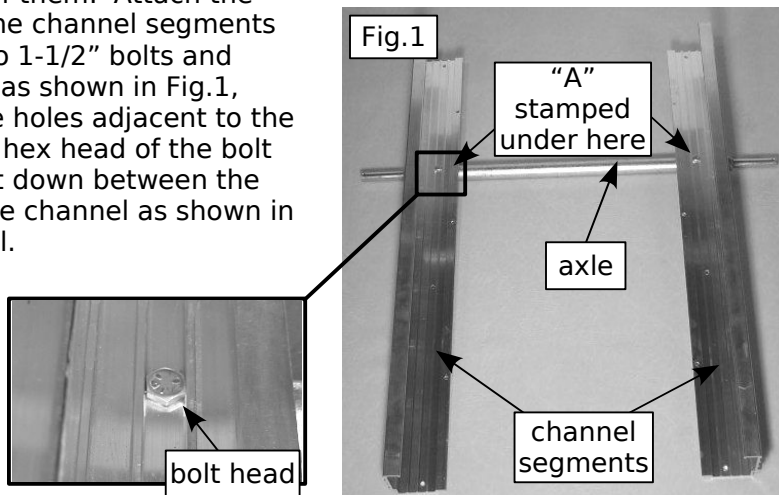

2. Attach the two long crossmembers (they have black caps on the ends) and one short crossmember to the channel segments using 1-1/2" bolts and nuts as shown in Fig.2. The hex head of the bolt should fit down between the ribs of the channel as noted above. NOTE: Do not tighten the nuts on the crossmembers too tightly or you will crimp the tubing!

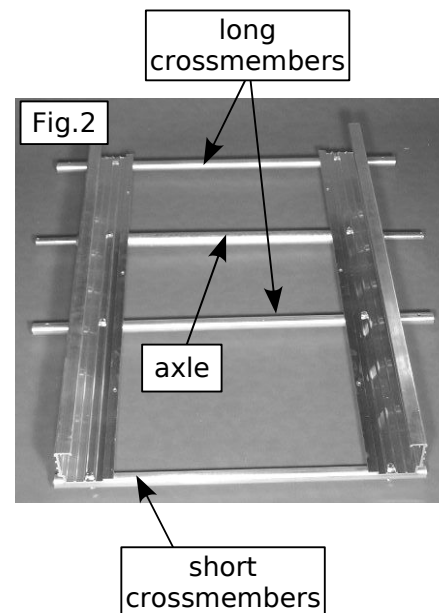

3. **Model 32A skip to step 6.** Connect each remaining pair of channel segments together with two short crossmembers and four 1-1/2" bolts and nuts. The heads of the bolts should fit between the ribs of the channel as shown above.

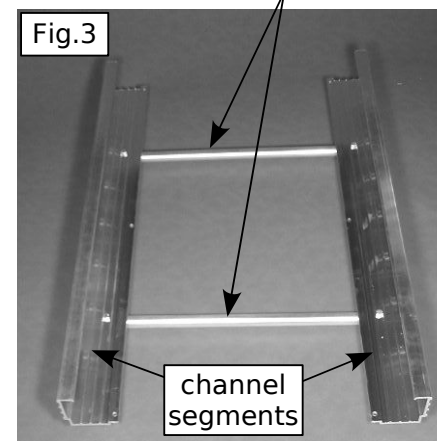

4. Choose the preferred configuration for your trailer from the table at right. Lay out the completed frame section assemblies end-to-end to match your chosen configuration as seen in Fig.4.

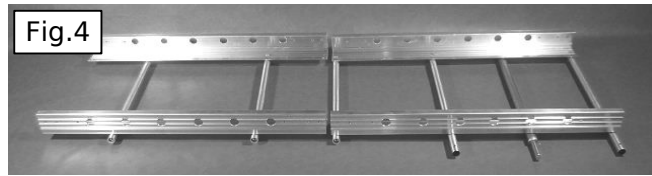

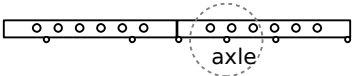
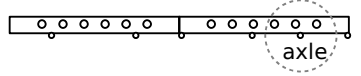
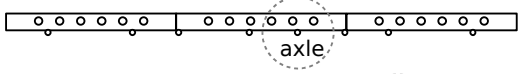
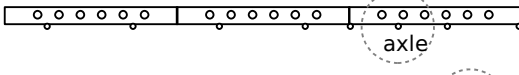
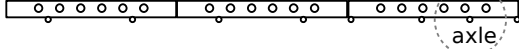
configuration:	length of load:
	< 5'6" long (1.67m)
	5' 6" - 9' (1.67-2.74m)
	< 8' long (2.44 m)
	8' - 12' (2.44 - 3.66m)
	12' - 15' (3.66m - 4.57m)

5. Connect the channel segments with splice plates and 3/4" bolts in the outermost holes as shown in Fig.5 & 6. Thread a plain hex nut on one leg of each U-bolt until the nut is three-quarters up the leg of the U-bolt. Insert two U-bolts in the remaining holes as shown in Fig.5. Thread four locknuts on the ends of the 3/4" bolts and on the ends of the U-bolts that have a nut on the outside (Fig.6). Hold the head of the bolts in the slot on the outside of the channel with your thumb as you tighten the locknuts securely.

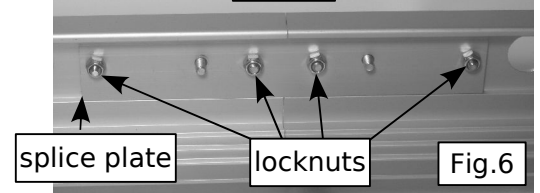
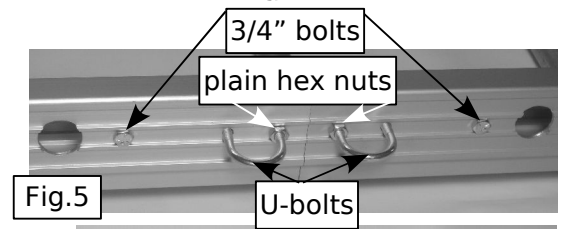

6. Mount the corner brackets on the rectangular rear crossmember (the one with the sticker) using four 1-1/2" bolts and locknuts (Fig.7). Note that the brackets are mounted on the side opposite the sticker, and that the notches on the brackets should point up in the same direction as the BAW sticker (Fig.8).

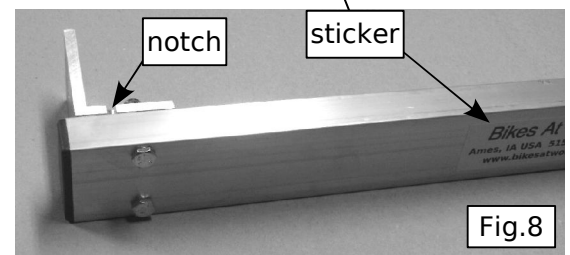
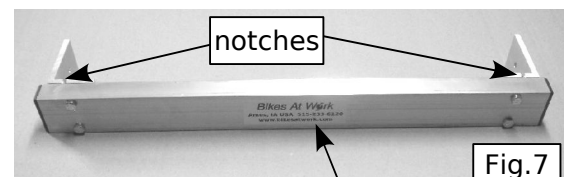

7. Slide the rear crossmember assembly into the channel on the rear of the trailer as shown in Fig.9 and secure using two U-bolts and two locknuts (Fig.10). Install a locknut only on the leg of the U-bolt with an exterior nut.

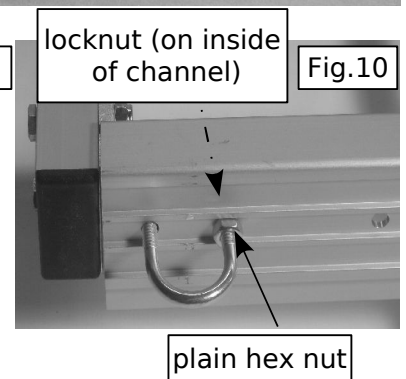
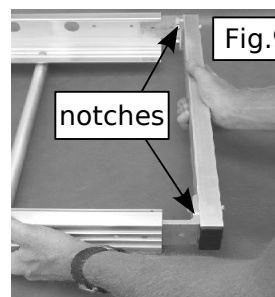

8. Repeat steps 6 & 7 for the front rectangular crossmember (the crossmember without the sticker), mounting the crossmember on the other end of the trailer. Tighten all the bolts and nuts used in steps 6, 7, and 8 completely.

9. Mount the U-bolts and saddles over the short end of the towbar (Fig.11). Make sure the bend in the towbar is in the orientation as shown relative to the clamps. Place the square spacer on top of the front rectangular crossmember and put the U-bolts through the holes in the spacer and below the rectangular crossmember (Fig.12). Mount the two short plates over the ends of the U-bolts (Fig.13). Center the towbar mounting assembly on the front crossmember, then secure in place with 5/16" locknuts on the ends of the U-bolts (Fig.14). With the towbar horizontal (parallel to the trailer frame), tighten the nuts **as tightly as you can** to keep it from slipping. When installed, the towbar should resemble Fig.15.

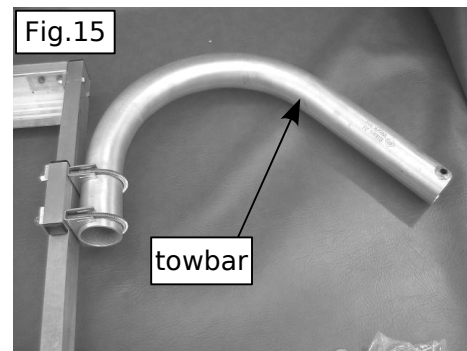
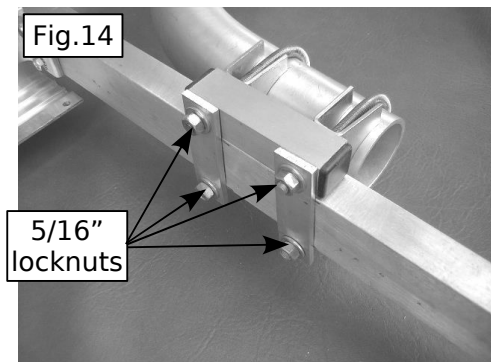
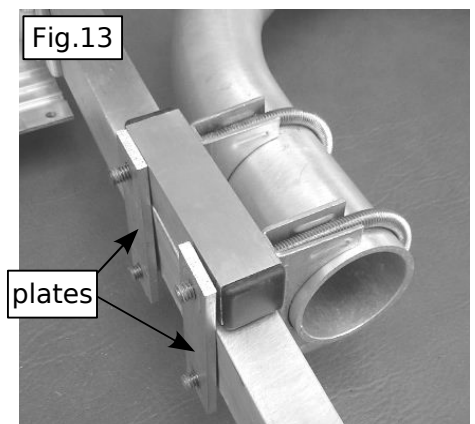
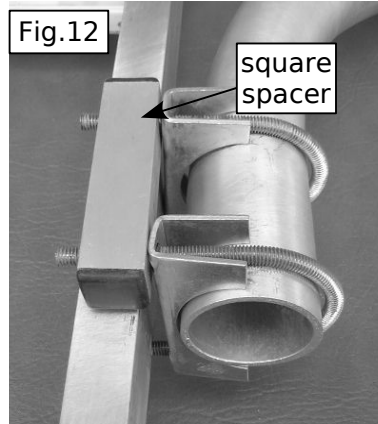
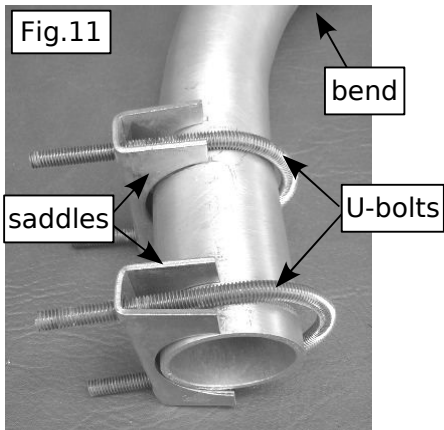

10. Attach the fenders to the fender crossmembers using 1-1/2" bolts and nuts (Fig.16) and tighten completely.

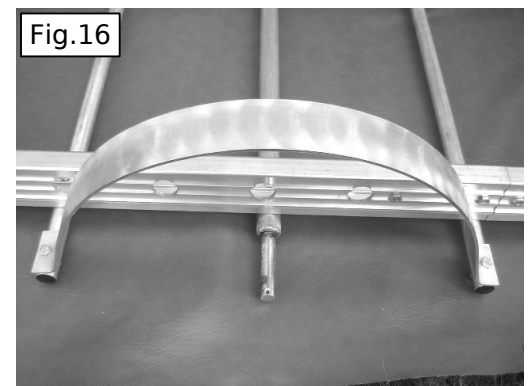

11. Place the wheels over the ends of the axle (Fig.17).



12. Place a wheel spacer over each end of the axle and insert a pin through the hole to secure it in place as shown in Fig.18. The loop of each pin should snap over the axle when fully installed as shown in Fig.19.

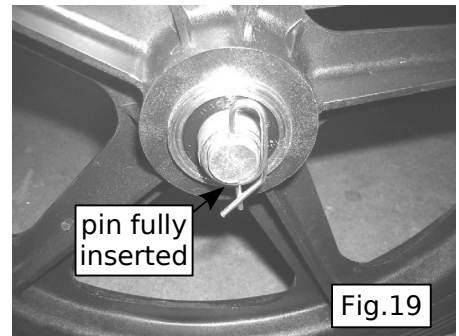
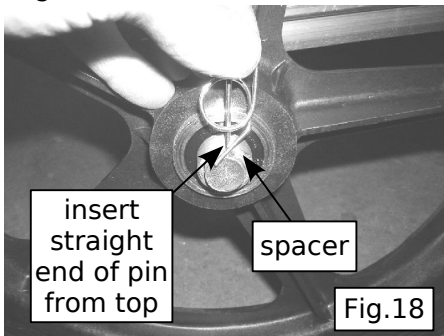

13. Fasten a washer to each end of the short crossmembers using a 3/4" bolt (Fig.20). This will prevent the shock cords from slipping off the end when they are used as tie-down points.

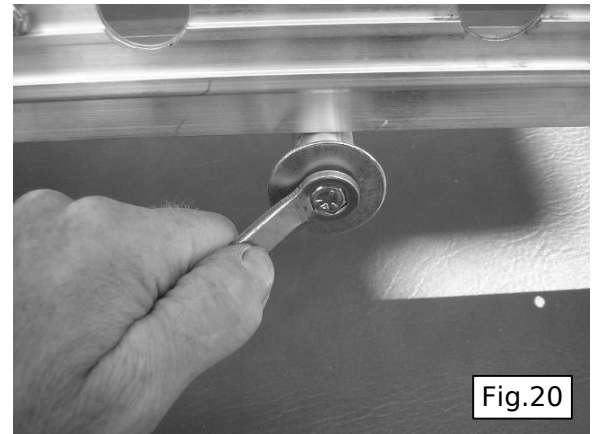

14. Mount the self-adhesive reflectors on the rear trailer crossmember as shown in Fig.21.

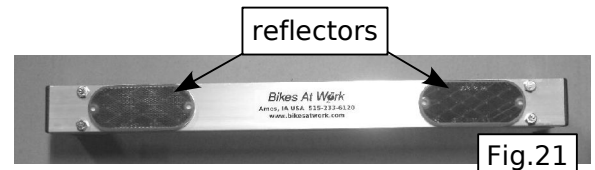

15. You can now hang your shock cords around the crossmembers for easy access as shown in Fig.22.

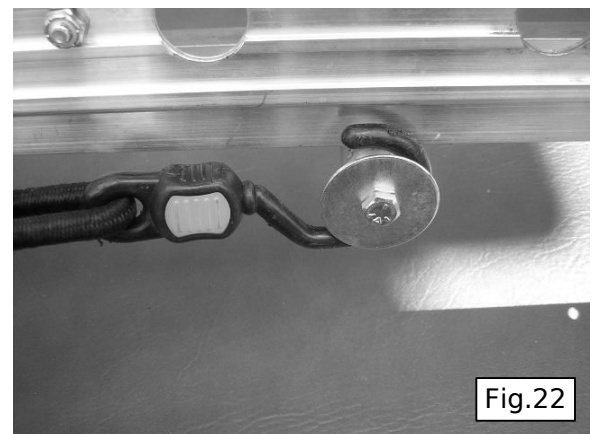

The trailer assembly is complete. See the:

Hitch Mounting Instructions,
Attaching the Trailer to the Hitch Instructions, and
Tips for Using Your Trailer Safely

and you'll soon be ready to use your new trailer.

For minimal rolling resistance, check tire pressure before each use.